

PzS & PzV *Nova trans* Batteries as mobile power



ENERGY FROM BATTERIES 

BAE motive power batteries – Individual solutions in series

The right battery for every application

High performance, reliability, low maintenance – these are the prime qualities of BAE batteries. Modular in design, they are more powerful than DIN standards require and can be used in numerous

applications. They are the batteries of choice for heavy duty and universal applications. And they are maintenance-free. We have the right battery for every electric vehicle.

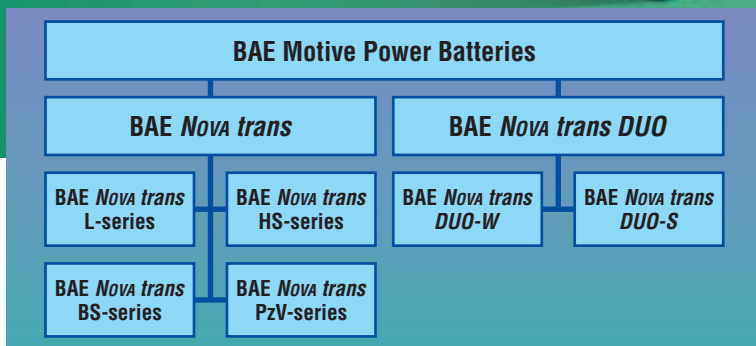

- **Nova trans PzV**
Maintenance-free
– Unique GEL-technology:
no topping up and high cycle life.

Our programme at a glance:

BAE Nova trans The power horse

- **Nova trans L**
– Motive power batteries according to IEC 254-1 and 2.
- **Nova trans HS**
– High performance batteries with approx. 10 % more energy in the same cell dimensions as the L-series.
- **Nova trans BS**
High energy density and small external dimensions, designed for small electric vehicles.

BAE Nova trans DUO The air-lift battery – with acid circulation

- **Nova trans DUO-W**
– Lowest maintenance with longer topping-up intervals compared to standard versions.
 - **Nova trans DUO-S**
– For heavy duty. One battery for two shifts due to interim charging. Ideal replacement battery for a 3-shift duty because of a short and efficient charging.
- Both series are highly economic. Due to a charging factor of 1.05 they save 15 – 20 % of energy.*

BAE *Nova trans* Battery technology

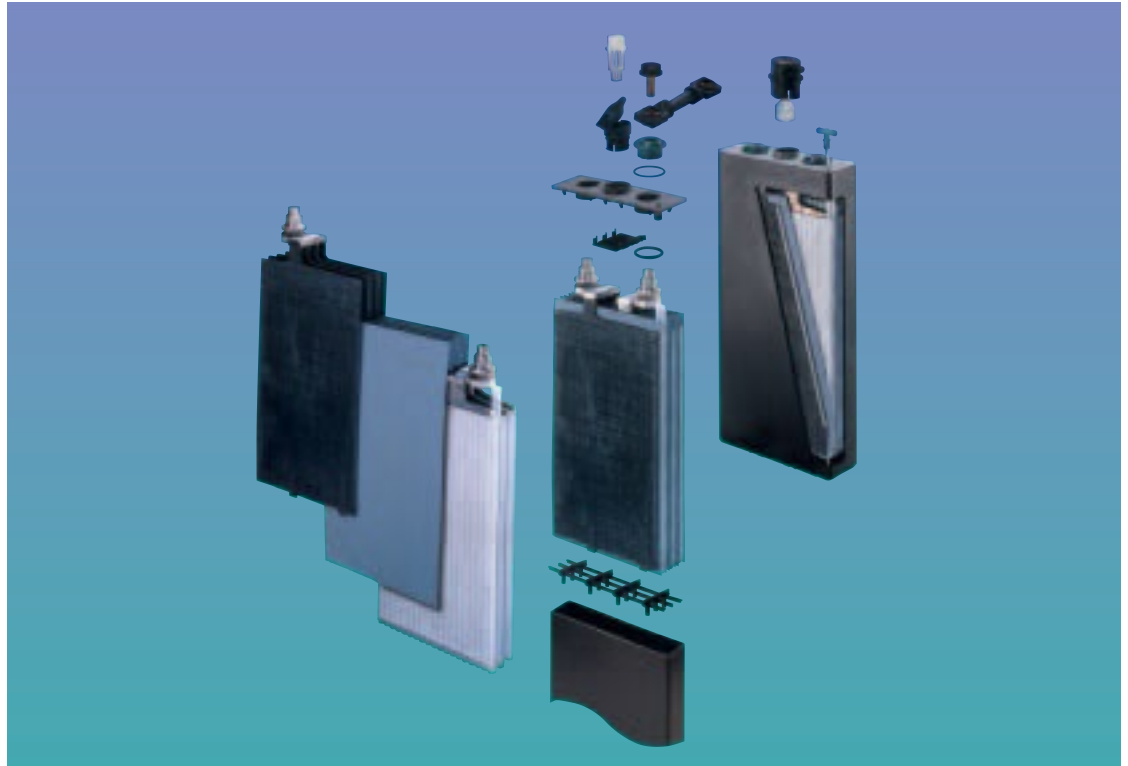

Quality throughout

The negative plates used in BAE batteries are equipped with highly durable longlife expander to cope with high cycle life. They are welded to the pole of the negative plate set, which in turn interlocks with the positive set which consists of tough tubular plates with corrosion resistant grids.

The cell jar is made of unbreakable and temperatureresistant polypropylene and is welded acid-tightly to the cell lid.

The pole, having a brass inlay, is screwed to the lid, with a special BAE pole nut, sealing with two O-rings.

Topping up is carried out via a vent plug or an automatic refilling plug. DUO cells have an acid circulating device incorporated in the cell, driven by compressed air supply.

The cells can be connected with acid-resistant connectors to batteries of up to 24 V 360 Ah using stable, impact- and acid-resistant plastic trays or plasticcoated steel trays. For larger batteries the trays are made of plastic-coated steel. These are coated pore-free and are acidand corrosion resistant.

Highest state-of-the-art technology

Five important design characteristics given below determine the high technology of BAE motive power batteries.

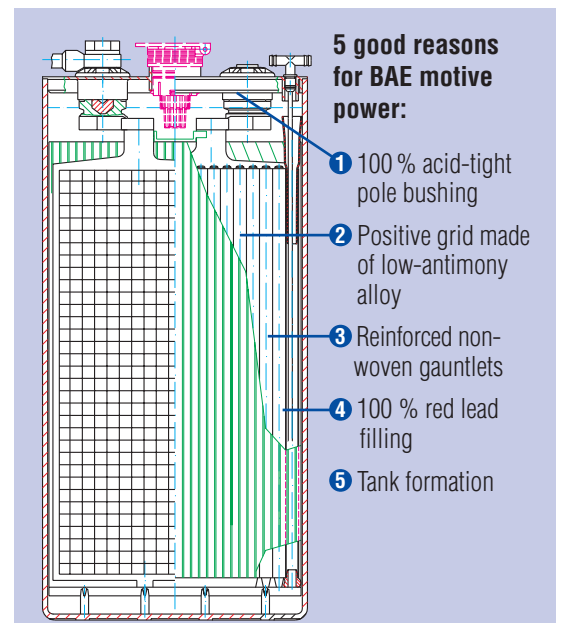

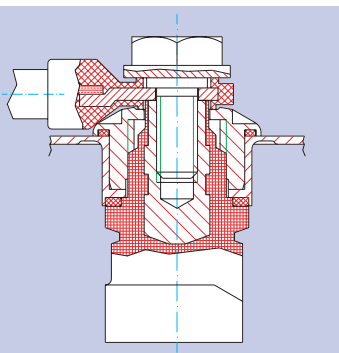

1 BAE pole bushing

The BAE pole bushing is a robust 100 % acid-tight whole of the pole and the lid, independent if a connector is screwed onto it or not. It is excluded that acid can destroy the pole or the connector.

The BAE pole has a machined lead shoulder below its thread. In this thread the BAE pole nut intervenes and presses the O-ring in axial direction between the lid and the lead shoulder of the pole. The pressing is limited by a stop on the pole. An additional O-ring within the pole nut stops any tracking current between the cell poles of a battery.

A plastic-headed steel pole screw assures a safe contact between the connector and the pole. In the middle of the plastic head a lead protected contact point is provided for an easy measurement of the cell voltages.



2 Low antimony alloy for positive grids

The BAE low antimony alloy for positive grids is reducing the ageing effects of traction batteries. During corrosion of the positive grid the low antimony alloy releases less antimony into the electrolyte. The antimony will be deposited on the surface of the negative grid. There it reduces the final charging

voltage, increases the hydrogen evolution and increases the temperature during charging. Less antimony in BAE batteries means:

- higher final charging voltage over life time
- lower hydrogen evolution, lower water loss
- lower temperatures at the end of charging

BAE alloys have besides the low antimony content additions of Sn, As and Cu to improve the casting of the grids, to reduce corrosion and to reduce the growth of the grid.

3 Gauntlet made of reinforced non-woven Polyester

The purpose of the gauntlets is to keep the active material together and to avoid mass shedding. BAE best choice are the reinforced non-woven gauntlets. Its improved oxidation resistance and stability provides high cycle numbers. Their small pores of 30 μ diameter reduce the mass shedding

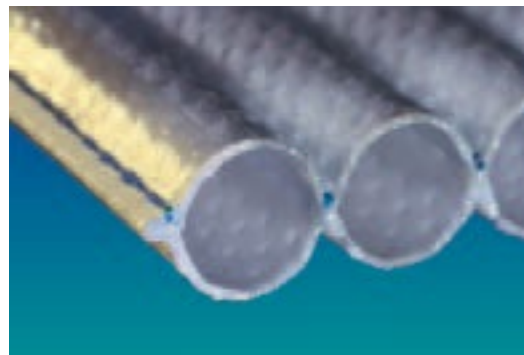

in comparison to woven gauntlets with pores of 90 μ . A special protection at the edges of the gauntlets guard against short circuits between the plates.

4 Dry filling with 100 % red lead

The particle structure of the active mass is important if uniform high capacity has to be achieved. During manufacture, the particle size distribution has to be precisely adjusted for this purpose. In order to restrict deposits to a minimum, the filling density must be kept within narrow tolerance limits. Dry filling with 100 % red lead

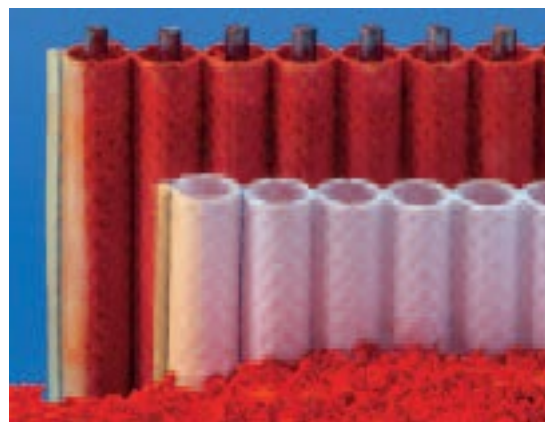

guarantees this much better than any other type of filling.

5 Tank formation

The quality of the positive and negative plates depends essentially on the acid density and temperature during the first formation charge. Ideal values, e. g. an acid density of 1.10 kg/l and a temperature of 40 °C, can be achieved in tank formation in contrast to cell formation and kept within strict tolerance levels.



BAE Acid circulation

Cost reduction every day

BAE *Nova trans DUO* – constantly in action

In contrast to conventional batteries where 17 % of the charging time is required for mixing the electrolyte in the cell, the BAE *Nova trans DUO* saves energy, charging time and water by injecting circulating air into each cell during the main charge. Battery heating is also reduced.

The advantages are:

- 20–30 % less charging time, without the need for higher electrical charge rating.
- Interim charging time substantially lower compared with conventional batteries.
- 15–20 % lower energy costs.
- 50–80 % less gas release and water consumption.
- Reduction of operating temperature by 5–10K.

BAE *Nova trans DUO* and *DUO* charger: technology adapted for both heavy duty (*DUO-S*) and decentralised (*DUO-W*) operation. This type of adaptation is also possible even after years of operation. Pressure monitoring and patented leak monitoring facilities guarantee safe electrolyte circulation.

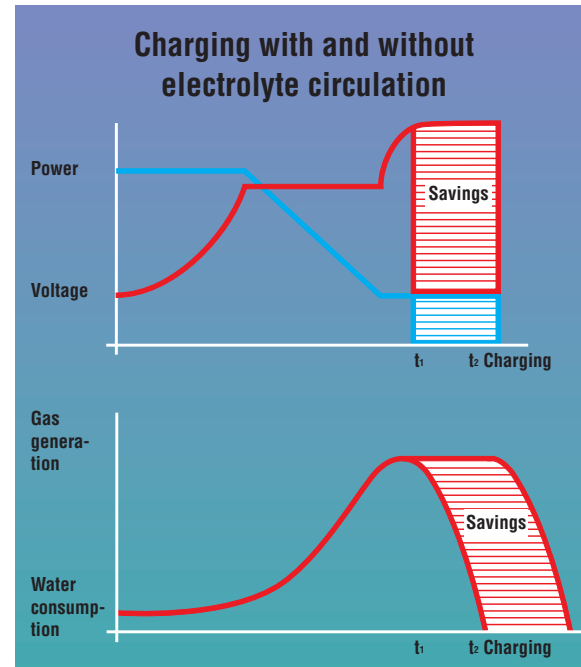

BAE *Nova trans PULS lift* – flexibility for all PzS batteries

The charging characteristic BAE *PULS lift* was developed by BAE together with a German charger manufacturer. The acid circulation is not made by injected air from a mechanical pump but by well defined current induced gas pulses during the final charging phase, having a charging factor of 1,07. Besides applications with many intermediate chargings the BAE *PULS lift* has the same advantages as the conventional acid circulation by using far less parts. No pump and no connection to the charger, no distribution hoses to each cell is required. It can

be used for all vented lead acid batteries. An equalisation charge during weekend is required.

The advantages:

- Applicable for all vented lead acid batteries
- No additional components
- Lower investment as for conventional acid circulation
- Lower maintenance as for conventional acid circulation
- Short charging times
- Lower temperature increase as with standard chargers

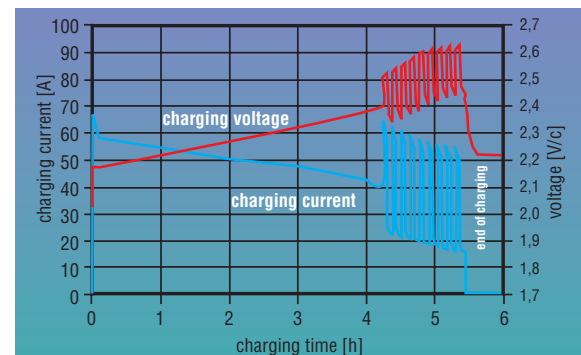

- Increased water filling intervals as with standard chargers
- Lower energy consumption as with standard chargers

2 V

Zellen/Cells

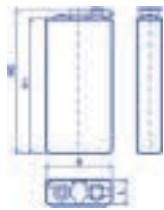

Cell type acc. IEC	Ident number wet	Ident number dry	Length L mm	Width B mm	Height H1 mm	Height H2 mm	Weight filled kg	Weight dry kg
Zellentyp nach IEC	Sachnummer gefüllt	Sachnummer trocken	Länge L mm	Breite B mm	Höhe H1 mm	Höhe H2 mm	Gewicht gef. kg	Gewicht trocken kg
2 PzS 120 L	0014000	2014000	47	198	340	370	8,4	6,5
3 PzS 180 L	0014001	2014001	65	198	340	370	11,8	9,2
4 PzS 240 L	0014002	2014002	83	198	340	370	15,5	12,8
5 PzS 300 L	0014003	2014003	101	198	340	370	19,0	16,2
6 PzS 360 L	0014004	2014004	119	198	340	370	22,5	18,5
7 PzS 420 L	0014005	2014005	137	198	340	370	26,1	21,2
8 PzS 480 L	0014006	2014006	155	198	340	370	29,8	24,4
9 PzS 540 L	0014007	2014007	173	198	340	370	33,1	26,9
10 PzS 600 L	0014008	2014008	192	198	340	370	36,8	30,1
2 PzS 160 L	0014009	2014009	47	198	405	435	9,8	7,5
3 PzS 240 L	0014010	2014010	65	198	405	435	14,0	11
4 PzS 320 L	0014011	2014011	83	198	405	435	18,1	14,2
5 PzS 400 L	0014012	2014012	101	198	405	435	22,6	18,5
6 PzS 480 L	0014013	2014013	119	198	405	435	26,6	21,4
7 PzS 560 L	0014014	2014014	137	198	405	435	31,1	24,8
8 PzS 640 L	0014015	2014015	155	198	405	435	35,2	27,7
9 PzS 720 L	0014016	2014016	173	198	405	435	39,6	31
10 PzS 800 L	0014017	2014017	192	198	405	435	43,9	33,8
2 PzS 180 L	0014018	2014018	47	198	475	505	12,0	9,4
3 PzS 270 L	0014019	2014019	65	198	475	505	16,9	13,3
4 PzS 360 L	0014020	2014020	83	198	475	505	21,6	17,6
5 PzS 450 L	0014021	2014021	101	198	475	505	26,3	21,4
6 PzS 540 L	0014022	2014022	119	198	475	505	31,1	25,2
7 PzS 630 L	0014023	2014023	137	198	475	505	36,1	29,1
8 PzS 720 L	0014024	2014024	155	198	475	505	40,8	32,9
9 PzS 810 L	0014025	2014025	173	198	475	505	46,0	37
10 PzS 900 L	0014026	2014026	192	198	475	505	50,3	40,2
2 PzS 230 L*	0014027	2014027	47	198	565	595	14,3	10,7
3 PzS 345 L*	0014028	2014028	65	198	565	595	20,3	15,8
4 PzS 460 L*	0014029	2014029	83	198	565	595	26,0	21,2
5 PzS 575 L*	0014030	2014030	101	198	565	595	31,8	24,7
6 PzS 690 L*	0014031	2014031	119	198	565	595	37,9	30
7 PzS 805 L*	0014032	2014032	137	198	565	595	43,8	35,7
8 PzS 920 L*	0014033	2014033	155	198	565	595	49,8	41,2
9 PzS1035 L*	0014034	2014034	173	198	565	595	55,7	44,7
10 PzS1150 L*	0014035	2014035	192	198	565	595	61,5	49,8
2 PzS 280 L	0014036	2014036	47	198	720	750	18,2	13
3 PzS 420 L	0014037	2014037	65	198	720	750	25,4	18,7
4 PzS 560 L	0014038	2014038	83	198	720	750	32,9	24,9
5 PzS 700 L	0014039	2014039	101	198	720	750	39,9	29,8
6 PzS 840 L	0014040	2014040	119	198	720	750	47,2	35,7
7 PzS 980 L	0014041	2014041	137	198	720	750	54,8	41,9
8 PzS1120 L	0014042	2014042	155	198	720	750	62,3	48,8
9 PzS1260 L	0014043	2014043	173	198	720	750	68,9	52,1
10 PzS1400 L	0014044	2014044	192	198	720	750	76,7	58,5
2 PzS 250 HS	0014045	2014045	47	198	570	600	14,9	11,3
3 PzS 375 HS	0014046	2014046	65	198	570	600	21,0	16,5
4 PzS 500 HS	0014047	2014047	83	198	570	600	26,5	21,7
5 PzS 625 HS	0014048	2014048	101	198	570	600	32,6	25,5
6 PzS 750 HS	0014049	2014049	119	198	570	600	38,5	30,6
7 PzS 875 HS	0014050	2014050	137	198	570	600	44,5	36,4
8 PzS1000 HS	0014051	2014051	155	198	570	600	50,6	42
9 PzS1125 HS	0014052	2014052	173	198	570	600	56,5	45,5
10 PzS1250 HS	0014053	2014053	192	198	570	600	62,1	50,4
2 PzS 310 HS	0014054	2014054	47	198	720	750	19,5	14,3
3 PzS 465 HS	0014055	2014055	65	198	720	750	26,9	20,2
4 PzS 620 HS	0014056	2014056	83	198	720	750	34,0	26
5 PzS 775 HS	0014057	2014057	101	198	720	750	42,1	32
6 PzS 930 HS	0014058	2014058	119	198	720	750	48,3	36,8
7 PzS1085 HS	0014059	2014059	137	198	720	750	56,6	43,7
8 PzS1240 HS	0014060	2014060	155	198	720	750	63,0	49,5
9 PzS1395 HS	0014061	2014061	173	198	720	750	73,0	56,2
10 PzS1550 HS	0014062	2014062	192	198	720	750	80,4	62,2

2 V

Sondertypen/Special types

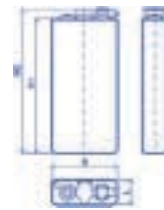

Cell type acc. IEC	Ident number wet	Ident number dry	Length L mm	Width B mm	Height H1 mm	Height H2 mm	Weight filled kg	Weight dry kg
Zellentyp nach IEC	Sachnummer gefüllt	Sachnummer trocken	Länge L mm	Breite B mm	Höhe H1 mm	Höhe H2 mm	Gewicht gef. kg	Gewicht trocken kg
2 PzS 220 LNB	0013227	2013227	47	198	545	575	13,9	10,4
3 PzS 330 LNB	0013228	2013228	65	198	545	575	19,8	15,5
4 PzS 440 LNB	0013229	2013229	83	198	545	575	25,4	20,9
5 PzS 550 LNB	0013230	2013230	101	198	545	575	31,1	24,4
6 PzS 660 LNB	0013231	2013231	119	198	545	575	37,1	29,7
7 PzS 770 LNB	0013232	2013232	137	198	545	575	42,9	35,4
8 PzS 880 LNB	0013233	2013233	155	198	545	575	48,9	40,9
9 PzS 990 LNB	0013234	2013234	173	198	545	575	54,7	44,4
10 PzS 1100 LNB	0013235	2013235	192	198	545	575	60,4	49,5
2 PzS 280 LNB	0014236	2014236	47	198	696	726	17,7	12,7
3 PzS 420 LNB	0014237	2014237	65	198	696	726	24,8	18,4
4 PzS 560 LNB	0014238	2014238	83	198	696	726	32,2	24,6
5 PzS 700 LNB	0014239	2014239	101	198	696	726	39,0	29,5
6 PzS 840 LNB	0014240	2014240	119	198	696	726	46,2	35,4
7 PzS 980 LNB	0014241	2014241	137	198	696	726	53,7	41,6
8 PzS 1120 LNB	0014242	2014242	155	198	696	726	61,0	48,5
9 PzS 1260 LNB	0014243	2014243	173	198	696	726	67,5	51,8
10 PzS 1400 LNB	0014244	2014244	192	198	696	726	75,2	58,2
2 PzS 300 HSNB	0014254	2014254	47	198	696	726	19,2	14,1
3 PzS 450 HSNB	0014255	2014255	65	198	696	726	26,5	20,0
4 PzS 600 HSNB	0014256	2014256	83	198	696	726	33,6	25,8
5 PzS 750 HSNB	0014257	2014257	101	198	696	726	41,6	31,7
6 PzS 900 HSNB	0014258	2014258	119	198	696	726	47,8	36,5
7 PzS 1050 HSNB	0014259	2014259	137	198	696	726	56,0	43,4
8 PzS 1200 HSNB	0014260	2014260	155	198	696	726	62,4	49,2
9 PzS 1350 HSNB	0014261	2014261	173	198	696	726	72,4	55,9
10 PzS 1500 HSNB	0014262	2014262	192	198	696	726	79,7	61,9

* Zellenhöhe H1 bei Zellen mit Elektrolytumwälzung: 570 mm / Height H1 for cells with air agitation: 570 mm!

24 V

DIN 43535 A



Cell type acc. IEC	Ident number	Number of steel tray	Length L mm	Width B mm	Height mm	Weight filled kg	Weight dry kg	Ident number	Number of steel tray	Length L mm	Width B mm	Height mm	Weight filled kg	Weight dry kg
Zellentyp nach IEC	Sachnummer	Trognummer (Stahl)	Länge L mm	Breite B mm	Höhe mm	Gewicht gef. kg	Gewicht trocken kg	Sachnummer	Trognummer (Stahl)	Länge L mm	Breite B mm	Höhe mm	Gewicht gef. kg	Gewicht trocken kg
2 PzS 120 L	0214000	5421001	830	165	402	138	115	0214045	5420801	624	212	402	129	106
3 PzS 180 L	0214001	5301701	830	219	402	177	146	0214046	5049501	624	284	402	182	151
4 PzS 240 L	0214002	5322201	830	273	402	224	192	0214047	5049601	624	356	402	205	173
5 PzS 300 L	0214003	5224501	830	327	402	270	236	0214048	5049701	624	428	402	240	206
6 PzS 360 L	0214004	5222101	830	381	402	295	247	0214049	5049801	624	500	402	320	272
7 PzS 420 L	0214005	5148001	830	435	402	336	277	0214050	5039501	624	572	402	363	304
8 PzS 480 L	0214006	5022401	830	489	402	435	370	0214051	5022501	624	644	402	390	325
9 PzS 540 L	0214007	5148101	830	546	402	460	386	0214052	5148501	624	716	402	475	401
10 PzS 600 L	0214008	5148201	830	600	402	550	510	0214053	5148601	624	788	402	520	440
2 PzS 160 L	0214009	5220301	830	165	462	157	130	0214054	5220501	624	212	462	150	122
3 PzS 240 L	0214010	5013001	830	219	462	211	175	0214055	5321601	624	284	462	204	168
4 PzS 320 L	0214011	5000501	830	273	462	264	217	0214056	5120301	624	356	462	257	210
5 PzS 400 L	0214012	5224101	830	327	462	321	272	0214057	5224701	624	428	462	314	265
6 PzS 480 L	0214013	5222201	830	381	462	374	312	0214058	5049901	624	500	462	367	305
7 PzS 560 L	0214014	5094301	830	435	462	431	355	0214059	5094001	624	572	462	489	413
8 PzS 640 L	0214015	5049101	830	489	462	487	397	0214060	5094401	624	644	462	479	389
9 PzS 720 L	0214016	5148301	830	546	462	540	437	0214061	5016401	624	716	462	555	452
10 PzS 800 L	0214017	5051801	830	600	462	600	480	0214062	5148701	624	788	462	615	494
2 PzS 180 L	0214018	5007401	830	165	537	189	158	0214063	5007001	624	212	537	180	149
3 PzS 270 L	0214019	5013501	830	219	537	251	208	0214064	5121001	624	284	537	243	200
4 PzS 360 L	0214020	5223001	830	273	537	312	264	0214065	5223301	624	356	537	303	255
5 PzS 450 L	0214021	5042401	830	327	537	371	312	0214066	5042001	624	428	537	363	304
6 PzS 540 L	0214022	5222301	830	381	537	433	362	0214067	5016501	624	500	537	425	354
7 PzS 630 L	0214023	5222401	830	435	537	497	413	0214068	5016601	624	572	537	489	405
8 PzS 720 L	0214024	5222501	830	489	537	558	463	0214069	5148801	624	644	537	549	454
9 PzS 810 L	0214025	5148401	830	546	537	650	542	0214070	5148901	624	716	537	640	532
10 PzS 900 L	0214026	5222601	830	600	537	680	559	0214071	5149001	624	788	537	700	579
2 PzS 230 L	0214027	5220201	830	165	627	222	179	0214072	5000601	624	212	627	212	169
3 PzS 345 L	0214028	5062201	830	219	627	298	244	0214073	5121601	624	284	627	288	234
4 PzS 460 L	0214029	5220701	830	273	627	372	314	0214074	5052101	624	356	627	362	304
5 PzS 575 L	0214030	5045001	830	327	627	445	360	0214075	5024701	624	428	627	435	350
6 PzS 690 L	0214031	5224001	830	381	627	524	429	0214076	5223401	624	500	627	513	418
7 PzS 805 L	0214032	5094701	830	435	627	600	503	0214077	5016901	624	572	627	588	491
8 PzS 920 L	0214033	5044401	830	489	627	676	573	0214078	5044801	624	644	627	664	561
9 PzS1035 L	0214034	5222701	830	546	627	752	620	0214079	5140801	624	716	627	770	638
10 PzS1150 L	0214035	5055001	830	600	627	852	712	0214080	5141001	624	788	627	850	710
2 PzS 280 L	0214036	5034401	835	169	784	308	246	0214081	5149101	628	216	784	280	218
3 PzS 420 L	0214037	5062101	835	223	784	402	322	0214082	5062601	628	288	784	385	305
4 PzS 560 L	0214038	5001301	835	277	784	502	406	0214083	5020101	628	360	784	480	384
5 PzS 700 L	0214039	5063001	835	331	784	591	470	0214084	5149201	628	432	784	574	453
6 PzS 840 L	0214040	5224401	835	385	784	687	549	0214085	5017101	628	504	784	670	532
7 PzS 980 L	0214041	5094201	835	439	784	786	631	0214086	5149301	628	576	784	768	613
8 PzS1120 L	0214042	5014001	835	493	784	883	721	0214087	5441601	628	648	784	864	702
9 PzS1260 L	0214043	5222901	835	550	784	970	768	0214088	5141301	628	720	784	950	748
10 PzS1400 L	0214044	5049401	835	604	784	1072	854	0214089	5141501	628	792	784	1050	832
2 PzS 250 HS	0214135	5220201	830	165	627	233	190	0214153	5000601	624	212	627	215	172
3 PzS 375 HS	0214136	5062201	830	219	627	300	246	0214154	5121601	624	284	627	294	240
4 PzS 500 HS	0214137	5220701	830	273	627	375	317	0214155	5052101	624	356	627	365	308
5 PzS 625 HS	0214138	5045001	830	327	627	449	364	0214156	5024701	624	428	627	440	355
6 PzS 750 HS	0214139	5224001	830	381	627	528	433	0214157	5223401	624	500	627	525	430
7 PzS 875 HS	0214140	5094701	830	435	627	605	508	0214158	5016901	624	572	627	595	498
8 PzS1000 HS	0214141	5044401	830	489	627	682	579	0214159	5044801	624	644	627	670	567
9 PzS1125 HS	0214142	5222701	830	546	627	760	628	0214160	5140801	624	716	627	785	653
10 PzS1250 HS	0214143	5055001	830	600	627	835	695	0214161	5141001	624	788	627	865	725
2 PzS 310 HS	0214144	5034401	835	169	784	315	253	0214162	5149101	628	216	784	290	228
3 PzS 465 HS	0214145	5062101	835	223	784	415	335	0214163	5062601	628	288	784	395	315
4 PzS 620 HS	0214146	5001301	835	277	784	515	419	0214164	5020101	628	360	784	495	399
5 PzS 775 HS	0214147	5063001	835	331	784	600	479	0214165	5149201	628	432	784	601	480
6 PzS 930 HS	0214148	5224401	835	385	784	690	552	0214166	5017101	628	504	784	684	546
7 PzS1085 HS	0214149	5094201	835	439	784	795	640	0214167	5149301	628	576	784	780	625
8 PzS1240 HS	0214150	5014001	835	493	784	895	733	0214168	5441601	628	648	784	880	718
9 PzS1395 HS	0214151	5222901	835	550	784	985	784	0214169	5141301	628	720	784	970	769
10 PzS1550 HS	0214152	5049401	835	604	784	1085	867	0214170	5141501	628	792	784	1075	857

Alle Batteriemeße sind Trogaußenmaße inklusive Beschichtung! / All dimensions are outer dimensions of the battery tray inclusive coating!

24 V

DIN 43535 C



Cell type acc. IEC	Ident number	Number of steel tray	Length L mm	Width B mm	Height mm	Weight filled kg	Weight dry kg
Zellentyp nach IEC	Sachnummer	Trognummer (Stahl)	Länge L mm	Breite B mm	Höhe mm	Gewicht gef. kg	Gewicht trocken kg
2 PzS 120 L	0214090	5089101	306	424	402	120	97
3 PzS 180 L	0214091	5301401	414	424	402	177	146
4 PzS 240 L	0214092	5322301	522	424	402	223	191
5 PzS 300 L	0214093	5067701	630	424	402	270	236
6 PzS 360 L	0214094	5149401	744	424	402	326	278
7 PzS 420 L	0214095	5149501	852	424	402	375	316
8 PzS 480 L	0214096	5149601	960	424	402	436	371
9 PzS 540 L	0214097	5149701	1068	424	402	485	411
10 PzS 600 L	0214098	5149801	1176	424	402	530	450
2 PzS 160 L	0214099	5220601	306	424	462	147	119
3 PzS 240 L	0214100	5013901	414	424	462	202	166
4 PzS 320 L	0214101	5120401	522	424	462	256	209
5 PzS 400 L	0214102	5062801	630	424	462	314	265
6 PzS 480 L	0214103	5078301	744	424	462	373	311
7 PzS 560 L	0214104	5039401	852	424	462	431	355
8 PzS 640 L	0214105	5149901	960	424	462	488	398
9 PzS 720 L	0214106	5150001	1068	424	462	570	467
10 PzS 800 L	0214107	5150101	1176	424	462	630	509
2 PzS 180 L	0214108	5007501	306	424	537	174	143
3 PzS 270 L	0214109	5150201	414	424	537	202	159
4 PzS 360 L	0214110	5150301	522	424	537	306	258
5 PzS 450 L	0214111	5043001	630	424	537	356	297
6 PzS 540 L	0214112	5042101	744	424	537	445	374
7 PzS 630 L	0214113	5150401	852	424	537	498	414
8 PzS 720 L	0214114	5150501	960	424	537	559	464
9 PzS 810 L	0214115	5150601	1068	424	537	645	537
10 PzS 900 L	0214116	5150701	1176	424	537	710	589
2 PzS 230 L	0214117	5000701	306	424	627	207	164
3 PzS 345 L	0214118	5121101	414	424	627	285	231
4 PzS 460 L	0214119	5150801	522	424	627	360	302
5 PzS 575 L	0214120	5039301	630	424	627	435	350
6 PzS 690 L	0214121	5055601	744	424	627	523	428
7 PzS 805 L	0214122	5150901	852	424	627	599	502
8 PzS 920 L	0214123	5019301	960	424	627	677	574
9 PzS1035 L	0214124	5140901	1068	424	627	780	648
10 PzS1150 L	0214125	5141201	1176	424	627	800	660
2 PzS 280 L	0214126	5151001	310	428	784	285	223
3 PzS 420 L	0214127	5062701	418	428	784	380	300
4 PzS 560 L	0214128	5022001	526	428	784	479	383
5 PzS 700 L	0214129	5063701	634	428	784	574	453
6 PzS 840 L	0214130	5048001	748	428	784	614	476
7 PzS 980 L	0214131	5151101	858	428	784	886	731
8 PzS1120 L	0214132	5014501	966	428	784	930	768
9 PzS1260 L	0214133	5141401	1074	428	784	960	758
10 PzS1400 L	0214134	5068201	1182	428	784	1065	847
2 PzS 250 HS	0214171	5000701	306	424	627	215	172
3 PzS 375 HS	0214172	5121101	414	424	627	292	238
4 PzS 500 HS	0214173	5150801	522	424	627	365	308
5 PzS 625 HS	0214174	5039301	630	424	627	440	355
6 PzS 750 HS	0214175	5055601	744	424	627	530	435
7 PzS 875 HS	0214176	5150901	852	424	627	610	513
8 PzS1000 HS	0214177	5019301	960	424	627	685	582
9 PzS1125 HS	0214178	5140901	1068	424	627	795	663
10 PzS1250 HS	0214179	5141201	1176	424	627	875	735
2 PzS 310 HS	0214180	5151001	310	428	784	290	228
3 PzS 465 HS	0214181	5062701	418	428	784	385	305
4 PzS 620 HS	0214182	5022001	526	428	784	527	431
5 PzS 775 HS	0214183	5063701	634	428	784	580	459
6 PzS 930 HS	0214184	5048001	748	428	784	620	482
7 PzS1085 HS	0214185	5151101	858	428	784	890	735
8 PzS1240 HS	0214186	5014501	966	428	784	945	783
9 PzS1395 HS	0214187	5141401	1074	428	784	975	773
10 PzS1550 HS	0214188	5068201	1182	428	784	1080	862

Alle Batteriemäße sind Trogaußenmaße inklusive Beschichtung! / All dimensions are outer dimensions of the battery tray inclusive coating!

48 V

DIN 43531 A



48 V

DIN 43535 B



Cell type acc. IEC	Ident number	Number of steel tray	Length L mm	Width B mm	Height mm	Weight filled kg	Weight dry kg	Ident number	Number of steel tray	Length L mm	Width B mm	Height mm	Weight filled kg	Weight dry kg
Zellentyp nach IEC	Sachnummer	Trognummer (Stahl)	Länge L mm	Breite B mm	Höhe mm	Gewicht gef. kg	Gewicht trocken kg	Sachnummer	Trognummer (Stahl)	Länge L mm	Breite B mm	Höhe mm	Gewicht gef. kg	Gewicht trocken kg
2 PzS 120 L	0234189	5035301	830	316	402	232	186	0234234	5152701	1030	259	402	248	202
3 PzS 180 L	0234190	5020501	830	414	402	315	253	0234235	5026401	1030	349	402	336	274
4 PzS 240 L	0234191	5035101	830	522	402	397	332	0234236	5022301	1030	439	402	431	366
5 PzS 300 L	0234192	5069301	830	630	402	408	341	0234237	5025201	1030	529	402	521	454
6 PzS 360 L	0234193	5024601	830	738	402	584	488	0234238	5022201	1030	619	402	610	514
7 PzS 420 L	0234194	5151201	830	846	402	670	552	0234239	5152801	1030	709	402	703	585
8 PzS 480 L	0234195	5151301	830	954	402	765	635	0234240	5152901	1030	799	402	797	667
9 PzS 540 L	0234196	5151401	830	1062	402	920	771	0234241	5153001	1030	889	402	882	733
10 PzS 600 L	0234197	5151501	830	1170	402	1021	860	0234242	5153101	1030	979	402	977	816
2 PzS 160 L	0234198	5128801	830	316	462	287	232	0234243	5153201	1030	259	462	291	236
3 PzS 240 L	0234199	5049201	830	414	462	394	322	0234244	5153301	1030	349	462	394	322
4 PzS 320 L	0234200	5006801	830	522	462	500	406	0234245	5015601	1030	439	462	504	410
5 PzS 400 L	0234201	5263401	830	630	462	615	517	0234246	5015701	1030	529	462	617	519
6 PzS 480 L	0234202	5043101	830	738	462	720	595	0234247	5015801	1030	619	462	722	597
7 PzS 560 L	0234203	5025601	830	846	462	834	683	0234248	5153401	1030	709	462	835	684
8 PzS 640 L	0234204	5021701	830	954	462	946	766	0234249	5003101	1030	799	462	945	765
9 PzS 720 L	0234205	5151601	830	1062	462	1100	894	0234250	5015901	1030	889	462	1047	841
10 PzS 800 L	0234206	5151701	830	1170	462	1220	978	0234251	5038101	1030	979	462	1157	915
2 PzS 180 L	0234207	5152201	830	316	537	405	343	0234252	5003601	1030	259	537	347	285
3 PzS 270 L	0234208	5024901	830	414	537	489	403	0234253	5022601	1030	349	537	471	385
4 PzS 360 L	0234209	5014701	830	522	537	593	497	0234254	5077601	1030	439	537	594	498
5 PzS 450 L	0234210	5027301	830	630	537	712	594	0234255	5024001	1030	529	537	713	595
6 PzS 540 L	0234211	5022701	830	738	537	835	693	0234256	5027901	1030	619	537	836	694
7 PzS 630 L	0234212	5018401	830	846	537	963	795	0234257	5128401	1030	709	537	964	796
8 PzS 720 L	0234213	5018501	830	954	537	1084	894	0234258	5016701	1030	619	537	1083	893
9 PzS 810 L	0234214	5067301	830	1062	537	1205	989	0234259	5016801	1030	889	537	1211	995
10 PzS 900 L	0234215	5152301	830	1170	537	1382	1140	0234260	5021901	1030	979	537	1321	1079
2 PzS 230 L	0234216	5035201	830	316	627	453	367	0234261	5027601	1030	259	627	412	326
3 PzS 345 L	0234217	5013701	830	414	627	560	452	0234262	5039801	1030	349	627	564	456
4 PzS 460 L	0234218	5001501	830	522	627	708	593	0234263	5001101	1030	439	627	709	594
5 PzS 575 L	0234219	5001901	830	630	627	856	686	0234264	5012501	1030	529	627	856	686
6 PzS 690 L	0234220	5166001	830	738	627	1013	823	0234265	5166401	1030	619	627	1011	821
7 PzS 805 L	0234221	5032801	830	846	627	1162	968	0234266	5023501	1030	709	627	1159	965
8 PzS 920 L	0234222	5033101	830	954	627	1315	1109	0234267	5153501	1030	799	627	1312	1106
9 PzS 1035 L	0234223	5152401	830	1062	627	1524	1260	0234268	5153601	1030	889	627	1457	1193
10 PzS 1150 L	0234224	5142201	830	1170	627	1679	1398	0234269	5142301	1030	979	627	1603	1322
2 PzS 280 L	0234225	5145901	835	310	784	532	407	0234270	5107201	1035	263	784	534	409
3 PzS 420 L	0234226	5015101	835	418	784	739	578	0234271	5013601	1035	353	784	746	585
4 PzS 560 L	0234227	5002401	835	526	784	933	741	0234272	5048201	1035	443	784	937	745
5 PzS 700 L	0234228	5264501	835	634	784	1118	875	0234273	5264601	1035	533	784	1119	877
6 PzS 840 L	0234229	5266201	835	742	784	1309	1033	0234274	5266301	1035	623	784	1309	1033
7 PzS 980 L	0234230	5152501	835	850	784	1438	1128	0234275	5060701	1035	713	784	1467	1157
8 PzS 1120 L	0234231	5152601	835	958	784	1628	1304	0234276	5031701	1035	803	784	1696	1372
9 PzS 1260 L	0234232	5142401	835	1066	784	1796	1393	0234277	5142501	1035	893	784	1862	1459
10 PzS 1400 L	0234233	5140101	835	1174	784	1991	1554	0234278	5141601	1035	983	784	2064	1627
2 PzS 250 HS	0234324	5035201	830	316	627	457	371	0234342	5027601	1030	259	627	431	345
3 PzS 375 HS	0234325	5013701	830	414	627	565	457	0234343	5039801	1030	349	627	585	477
4 PzS 500 HS	0234326	5001501	830	522	627	714	599	0234344	5001101	1030	439	627	738	623
5 PzS 625 HS	0234327	5001901	830	630	627	863	693	0234345	5012501	1030	529	627	895	725
6 PzS 750 HS	0234328	5166001	830	738	627	1022	832	0234346	5166401	1030	619	627	1058	868
7 PzS 875 HS	0234329	5032801	830	846	627	1172	978	0234347	5023501	1030	709	627	1212	1018
8 PzS 1000 HS	0234330	5033101	830	954	627	1326	1120	0234348	5153501	1030	799	627	1371	1165
9 PzS 1125 HS	0234331	5152401	830	1062	627	1545	1281	0234349	5153601	1030	889	627	1476	1212
10 PzS 1250 HS	0234332	5142201	830	1170	627	1695	1414	0234350	5142301	1030	979	627	1615	1334
2 PzS 310 HS	0234333	5145901	835	310	784	563	438	0234351	5107201	1035	263	784	565	440
3 PzS 465 HS	0234334	5015101	835	418	784	764	603	0234352	5013601	1035	353	784	771	610
4 PzS 620 HS	0234335	5002401	835	526	784	964	772	0234353	5048201	1035	443	784	968	776
5 PzS 775 HS	0234336	5264501	835	634	784	1157	915	0234354	5264601	1035	533	784	1168	926
6 PzS 930 HS	0234337	5266201	835	742	784	1354	1078	0234355	5266301	1035	623	784	1354	1078
7 PzS 1085 HS	0234338	5152501	835	850	784	1480	1170	0234356	5060701	1035	713	784	1540	1230
8 PzS 1240 HS	0234339	5152601	835	958	784	1645	1321	0234357	5031701	1035	803	784	1746	1422
9 PzS 1395 HS	0234340	5142401	835	1066	784	1894	1491	0234358	5142501	1035	893	784	1960	1557
10 PzS 1550 HS	0234341	5140101	835	1174	784	2080	1643	0234359	5141601	1035	983	784	2153	1716

Alle Batteriemäße sind Trogaußenmaße inklusive Beschichtung! / All dimensions are outer dimensions of the battery tray inclusive coating!

48 V

DIN 43535 C



Cell type acc. IEC	Ident number	Number of steel tray	Length L mm	Width B mm	Height mm	Weight filled kg	Weight dry kg
Zellentyp nach IEC	Sachnummer	Trognummer (Stahl)	Länge L mm	Breite B mm	Höhe mm	Gewicht gef. kg	Gewicht trocken kg
2 PzS 120 L							
3 PzS 180 L							
4 PzS 240 L							
5 PzS 300 L							
6 PzS 360 L							
7 PzS 420 L							
8 PzS 480 L							
9 PzS 540 L							
10 PzS 600 L							
2 PzS 160 L							
3 PzS 240 L							
4 PzS 320 L							
5 PzS 400 L							
6 PzS 480 L							
7 PzS 560 L							
8 PzS 640 L							
9 PzS 720 L							
10 PzS 800 L							
2 PzS 180 L							
3 PzS 270 L							
4 PzS 360 L							
5 PzS 450 L							
6 PzS 540 L							
7 PzS 630 L							
8 PzS 720 L							
9 PzS 810 L							
10 PzS 900 L							
2 PzS 230 L							
3 PzS 345 L							
4 PzS 460 L							
5 PzS 575 L							
6 PzS 690 L							
7 PzS 805 L							
8 PzS 920 L							
9 PzS1035 L							
10 PzS1150 L							
2 PzS 280 L	0234315	5153701	1223	211	784	564	439
3 PzS 420 L	0234316	5015201	1223	283	784	750	589
4 PzS 560 L	0234317	5048301	1223	355	784	939	747
5 PzS 700 L	0234318	5020801	1223	427	784	1119	877
6 PzS 840 L	0234319	5058801	1223	499	784	1306	1030
7 PzS 980 L	0234320	-	1223	571	784	1498	1188
8 PzS1120 L	0234321	-	1223	643	784	1688	1364
9 PzS1260 L	0234322	5142601	1223	715	784	1842	1439
10 PzS1400 L	0234323	5141701	1223	787	784	2040	1603
2 PzS 250 HS							
3 PzS 375 HS							
4 PzS 500 HS							
5 PzS 625 HS							
6 PzS 750 HS							
7 PzS 875 HS							
8 PzS1000 HS							
9 PzS1125 HS							
10 PzS1250 HS							
2 PzS 310 HS	0234369	5153701	1223	211	784	595	470
3 PzS 465 HS	0234370	5015201	1223	283	784	775	614
4 PzS 620 HS	0234371	5048301	1223	355	784	969	777
5 PzS 775 HS	0234372	5020801	1223	427	784	1158	916
6 PzS 930 HS	0234373	5058801	1223	499	784	1350	1074
7 PzS1085 HS	0234374	-	1223	571	784	1548	1238
8 PzS1240 HS	0234375	-	1223	643	784	1744	1420
9 PzS1395 HS	0234376	5142601	1223	715	784	1940	1537
10 PzS1550 HS	0234377	5141701	1223	787	784	2129	1692

Alle Batteriemäße sind Trogaußenmaße inklusive Beschichtung! / All dimensions are outer dimensions of the battery tray inclusive coating!

80 V

DIN 43536 A

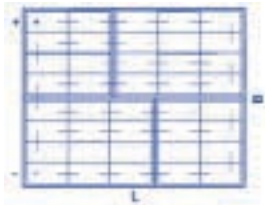

Cell type acc. IEC	Ident number	Number of steel tray	Length L mm	Width B mm	Height mm	Weight filled kg	Weight dry kg		Ident number	Number of steel tray	Length L mm	Width B mm	Height mm	Weight filled kg	Weight dry kg
Zellentyp nach IEC	Sachnummer	Trognummer (Stahl)	Länge L mm	Breite B mm	Höhe mm	Gewicht gef. kg	Gewicht trocken kg		Sachnummer	Trognummer (Stahl)	Länge L mm	Breite B mm	Höhe mm	Gewicht gef. kg	Gewicht trocken kg
2 PzS 120 L	0254378	-	1026	420	402	421	345		0254423	-	844	516	402	418	342
3 PzS 180 L	0254379	5171501	1026	564	402	580	476		0254424	5013201	844	696	402	580	476
4 PzS 240 L	0254380	5172301	1026	708	402	733	625		0254425	-	844	876	402	730	622
5 PzS 300 L	0254381	5125601	1026	852	402	868	756		0254426	-	844	1064	402	885	773
6 PzS 360 L	0254382	-	1026	996	402	1055	895		0254427	5103201	844	1244	402	1035	875
7 PzS 420 L	0254383	-	1026	1140	402	1188	992		0254428	-	844	1424	402	1192	996
8 PzS 480 L	0254384	-	1026	1284	402	1348	1132		0254429	-	844	1604	402	1354	1138
9 PzS 540 L	0254385	-	1026	1430	402	1492	1244		0254430	-	844	1784	402	1499	1251
10 PzS 600 L	0254386	-	1026	1582	402	1653	1385		0254431	-	844	1964	402	1661	1393
2 PzS 160 L	0254387	-	1026	420	462	495	403		0254432	5172901	844	516	462	495	403
3 PzS 240 L	0254388	5127801	1026	564	462	679	559		0254433	5000201	844	696	462	679	559
4 PzS 320 L	0254389	5273001	1026	708	462	858	702		0254434	5172001	844	876	462	860	704
5 PzS 400 L	0254390	5013301	1026	852	462	1049	885		0254435	5172201	844	1064	462	1055	891
6 PzS 480 L	0254391	5004101	1026	996	462	1226	1018		0254436	-	844	1244	462	1214	1006
7 PzS 560 L	0254392	5000101	1034	1140	462	1417	1165		0254437	-	844	1424	462	1409	1157
8 PzS 640 L	0254393	5050601	1034	1284	462	1605	1305		0254438	-	844	1604	462	1588	1288
9 PzS 720 L	0254394	-	1034	1430	462	1765	1421		0254439	-	844	1784	462	1780	1436
10 PzS 800 L	0254395	5104001	1034	1582	462	1960	1556		0254440	-	844	1964	462	1968	1564
2 PzS 180 L	0254396	-	1026	420	537	585	481		0254441	5171201	844	516	537	585	481
3 PzS 270 L	0254397	-	1026	564	537	796	652		0254442	5172701	844	696	537	807	663
4 PzS 360 L	0254398	5026601	1026	708	537	1015	855		0254443	5172101	844	876	537	1013	853
5 PzS 450 L	0254399	5273101	1026	852	537	1215	1019		0254444	5172501	844	1064	537	1216	1020
6 PzS 540 L	0254400	5028001	1026	996	537	1424	1188		0254445	5019101	844	1244	537	1370	1134
7 PzS 630 L	0254401	5014101	1034	1140	537	1640	1360		0254446	5026501	844	1424	537	1600	1320
8 PzS 720 L	0254402	5276101	1034	1284	537	1841	1525		0254447	-	844	1604	537	1804	1488
9 PzS 810 L	0254403	5032901	1034	1430	537	2010	1650		0254448	-	844	1784	537	2042	1682
10 PzS 900 L	0254404	-	1034	1582	537	2235	1831		0254449	-	844	1964	537	2231	1827
2 PzS 230 L	0254405	-	1026	420	627	692	548		0254450	-	844	516	627	686	542
3 PzS 345 L	0254406	5013801	1026	564	627	965	785		0254451	5172801	844	696	627	958	778
4 PzS 460 L	0254407	5062301	1026	708	627	1210	1018		0254452	5172601	844	876	627	1208	1016
5 PzS 575 L	0254408	5174501	1026	852	627	1458	1174		0254453	5172401	844	1064	627	1459	1175
6 PzS 690 L	0254409	5276301	1026	996	627	1721	1405		0254454	5027501	844	1244	627	1706	1390
7 PzS 805 L	0254410	5000301	1034	1140	627	1971	1647		0254455	-	844	1424	627	1961	1637
8 PzS 920 L	0254411	5276201	1034	1284	627	2228	1884		0254456	-	844	1604	627	2220	1876
9 PzS1035 L	0254412	5093601	1034	1430	627	2480	2040		0254457	5141801	844	1784	627	2474	2034
10 PzS1150 L	0254413	5142701	1034	1582	627	2710	2242		0254458	5142801	844	1964	627	2725	2257
2 PzS 280 L	0254414	-	1028	423	784	904	696		0254459	-	844	516	784	894	686
3 PzS 420 L	0254415	5062501	1028	567	784	1238	970		0254460	5006901	844	696	784	1209	941
4 PzS 560 L	0254416	5063101	1028	711	784	1558	1238		0254461	5027401	844	876	784	1410	1090
5 PzS 700 L	0254417	5040301	1028	855	784	1863	1459		0254462	5025301	844	1064	784	1848	1444
6 PzS 840 L	0254418	5276001	1028	999	784	2178	1718		0254463	-	844	1244	784	2161	1701
7 PzS 980 L	0254419	5088901	1037	1143	784	2505	1989		0254464	-	844	1424	784	2492	1976
8 PzS1120 L	0254420	-	1037	1287	784	2824	2284		0254465	-	844	1604	784	2818	2278
9 PzS1260 L	0254421	5142901	1037	1433	784	3091	2419		0254466	5143001	844	1784	784	3109	2437
10 PzS1400 L	0254422	5140601	1037	1585	784	3426	2698		0254467	5141901	844	1964	784	3448	2720
2 PzS 250 HS	0254468	-	1026	420	627	716	572		0254486	-	844	516	627	710	566
3 PzS 375 HS	0254469	5013801	1026	564	627	973	793		0254487	5172801	844	696	627	966	786
4 PzS 500 HS	0254470	5062301	1026	708	627	1220	1028		0254488	5172601	844	876	627	1218	1026
5 PzS 625 HS	0254471	5174501	1026	852	627	1470	1186		0254489	5172401	844	1064	627	1064	780
6 PzS 750 HS	0254472	5276301	1026	996	627	1735	1419		0254490	5027501	844	1244	627	1730	1414
7 PzS 875 HS	0254473	5000301	1034	1140	627	1982	1658		0254491	-	844	1424	627	1989	1665
8 PzS1000 HS	0254474	5276201	1034	1284	627	2245	1901		0254492	-	844	1604	627	2252	1908
9 PzS1125 HS	0254475	5093601	1034	1430	627	2512	2072		0254493	5141801	844	1784	627	2506	2066
10 PzS1250 HS	0254476	5142701	1034	1582	627	2734	2266		0254494	5142801	844	1964	627	2749	2281
2 PzS 310 HS	0254477	-	1028	423	784	970	762		0254495	-	844	516	784	946	738
3 PzS 465 HS	0254478	5062501	1028	567	784	1279	1011		0254496	5006901	844	696	784	1269	1001
4 PzS 620 HS	0254479	5063101	1028	711	784	1600	1280		0254497	5027401	844	876	784	1454	1134
5 PzS 775 HS	0254480	5040301	1028	855	784	1927	1523		0254498	5025301	844	1064	784	1936	1532
6 PzS 930 HS	0254481	5276001	1028	999	784	2249	1789		0254499	-	844	1244	784	2205	1745
7 PzS1085 HS	0254482	5088901	1037	1143	784	2555	2039		0254500	-	844	1424	784	2564	2048
8 PzS1240 HS	0254483	-	1037	1287	784	2832	2292		0254501	-	844	1604	784	2846	2306
9 PzS1395 HS	0254484	5142901	1037	1433	784	3255	2583		0254502	5143001	844	1784	784	3273	2601
10 PzS1550 HS	0254485	5140601	1037	1585	784	3580	2852		0254503	5141901	844	1964	784	3596	2868

Alle Batteriemeße sind Trogaußenmaße inklusive Beschichtung! / All dimensions are outer dimensions of the battery tray inclusive coating!

2 V

Zellen/Cells

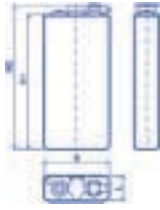

**Geschlossene Zellen
Baureihe
British Standard (BS)**

**Vented Lead Acid cells
(VLA)
Type British Standard**

Cell type	capacity C5 (Ah)	Ident number wet	Ident number dry	Length L mm	Width B mm	Height H1 mm	Height H2 mm	Weight filled kg	Weight dry kg
Zellentyp	Kapazität K5 (Ah)	Sach- nummer gefüllt	Sach- nummer trocken	Länge L mm	Breite B mm	Höhe H1 mm	Höhe H2 mm	Gewicht gef. kg	Gewicht trocken kg
2 PzB 130E	136	0021221	2021221	45	157,5	450	480	9,6	7,9
3 PzB 195E	204	0021222	2021222	61	157,5	450	480	13,1	10,4
4 PzB 260E	272	0021223	2021223	77	157,5	450	480	16,5	13,3
2 PzB 150E	160	0021232	2021232	45	157,5	510	540	11,0	9,0
3 PzB 225E	240	0021233	2021233	61	157,5	510	540	15,0	12,2
4 PzB 300E	320	0021234	2021234	77	157,5	510	540	19,0	15,4
2 PzB 200E	200	0021179	2021179	45	157,5	620	650	13,3	10,8
3 PzB 300E	300	0021180	2021180	61	157,5	620	650	18,9	14,8
4 PzB 400E	400	0021181	2021181	77	157,5	620	650	24,0	18,2

Elektrolytumwälzung ist nur bei Zellen mit 3 oder 4 positiven Platten möglich!

Air agitation is only possible for cells with 3 or 4 positive plates!

**Verschlossene Zellen
Baureihe PzV**

**Valve Regulated
Lead Acid cells (VRLA)
Type PzV**

2 V

Zellen/Cells

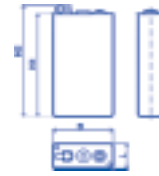

Cell type	Ident number	Length L mm	Width B mm	Height H1 mm	Height H2 mm	Weight kg
Zellentyp	Sachnummer	Länge L mm	Breite B mm	Höhe H1 mm	Höhe H2 mm	Gewicht kg
2 PzV 110	0032659	47	198	340	370	9,0
3 PzV 165	0031269	65	198	340	370	12,7
4 PzV 220	0032689	83	198	340	370	16,7
5 PzV 275	0032708	101	198	340	370	20,5
6 PzV 330	0032709	119	198	340	370	24,2
7 PzV 385	0032738	137	198	340	370	28,0
8 PzV 440	0031330	155	198	340	370	32,0
9 PzV 495	0032739	173	198	340	370	35,6
10 PzV 550	0032743	191	198	340	370	39,7
2 PzV 150	0031401	47	198	445	472	11,6
3 PzV 225	0031404	65	198	445	473	16,4
4 PzV 300	0031407	83	198	445	474	20,7
5 PzV 375	0031410	101	198	445	475	25,3
6 PzV 450	0031413	119	198	445	476	30,3
7 PzV 525	0031416	137	198	445	477	35,1
8 PzV 600	0031419	155	198	445	478	40,0
9 PzV 675	0031422	173	198	445	479	45,3
10 PzV 750	0031425	191	198	445	480	49,9
3 PzV 330	0031610	65	198	594	621	26,1
4 PzV 440	0031613	83	198	594	621	32,8
5 PzV 550	0031616	101	198	594	621	40,1
6 PzV 660	0031619	119	198	594	621	47,0
7 PzV 770	0031622	137	198	594	621	53,8
8 PzV 880	0031625	155	198	594	621	60,0
9 PzV 990	0031628	173	198	594	621	68,8
10 PzV 1100	0031631	191	198	594	621	75,4
3 PzV 375	0031505	65	198	696	723	30,3
4 PzV 500	0031508	83	198	696	723	38,0
5 PzV 625	0031511	101	198	696	723	46,5
6 PzV 750	0031514	119	198	696	723	54,4
7 PzV 875	0031517	137	198	696	723	62,2
8 PzV 1000	0031520	155	198	696	723	69,3
9 PzV 1125	0031523	173	198	696	723	79,5
10 PzV 1250	0031526	191	198	696	723	87,1

Not just batteries ...



It is not surprising that BAE is the company of choice as initial equipper of several European fork-lift truck manufacturers.



Whether for fork-lift trucks, palleting trucks or automatic guided vehicles – BAE batteries prove themselves on a daily basis, even under the harshest conditions.



Our performance, continuing after the sale, is completed:

- Tested quality according to DIN EN ISO 9001:2000
- 24-hour service facility
- Guaranteed returnability and recyclability



Berliner Batterie GmbH
Importateur France : EnerSafe France SAS
1, Caussarieu Nord
33210LEOGEATS-FRANCE
Tel. +33 (0) 557 310 353
Fax +33 (0) 557 310 354
E-mail: bae@enersafe.fr
www.enersafe.fr